

Embedded Bar Code Readers



APPLICATIONS

- OEM integration in automatic machines
- Chemical and biomedical analysis machines
- Document handling machines
- Print & Apply systems
- Packaging machines
- ATL (Automated Tape Library)

ADVANTAGES

- Excellent performance and reliability on all main bar code symbologies thanks to high scanning speed and advanced optic features.
- High reading performance on damaged or poorly printed bar codes
- Excellent performance on high resolution codes with reduced minimum reading distance

HIGHLIGHTS

- Extremely compact dimensions
- Very high density code reading (up to 0.076 mm / 3mils)
- Scanning speed up to 500 scans/s
- Dual serial interface
- Light weight (150 g / 5.29 oz. without cable)
- IP65 (NEMA 4) rugged industrial housing

GENERAL DESCRIPTION

DS2200 is designed for OEM and other applications requiring easy integration, high reliability and cost effectiveness. Datalogic Automation's advanced technology and experience in miniaturized laser components enables development of a compact industrial laser scanner without compromising reading performance and industrial quality standards.

In conformity with the needs of automatic machinery, DS2200 features very compact dimensions, light weight and IP65 rugged industrial housing.

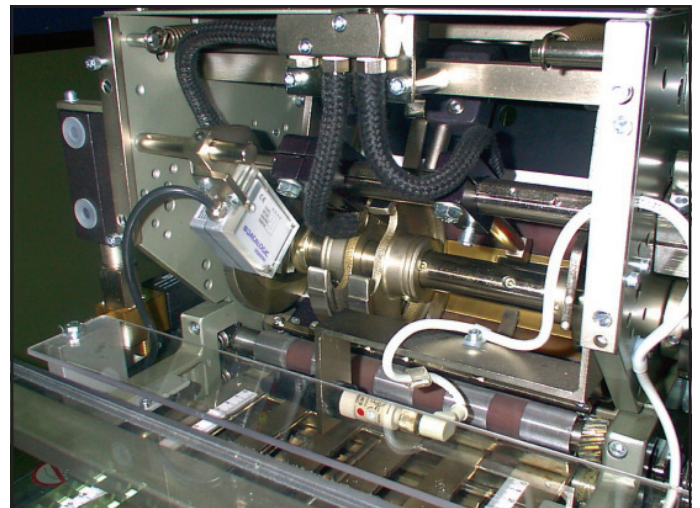
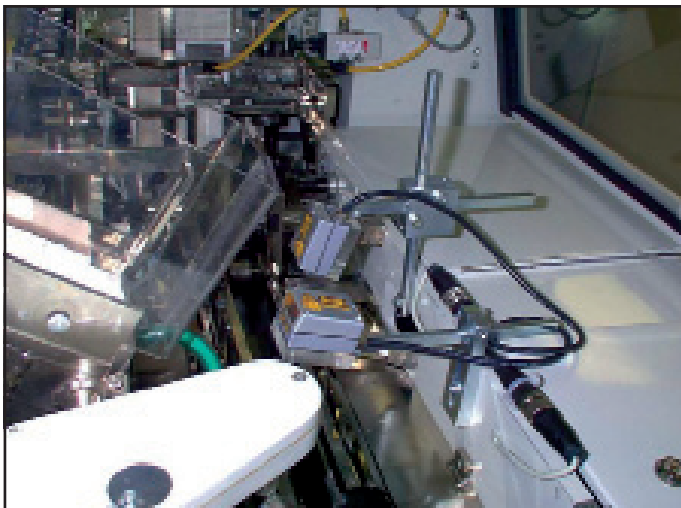

READING DIAGRAMS

DS2200-1XXX (STANDARD RESOLUTION)

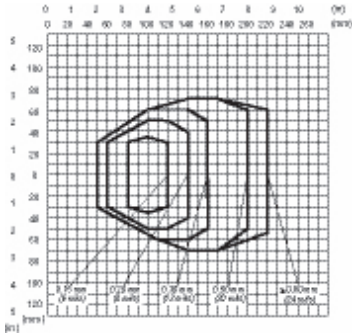

CONDITIONS

Code = Interleaved 2/5 or Code 39
 PCS = 0.90
 Pitch angle = 0°
 Skew angle = 15°
 Tilt angle = 0°

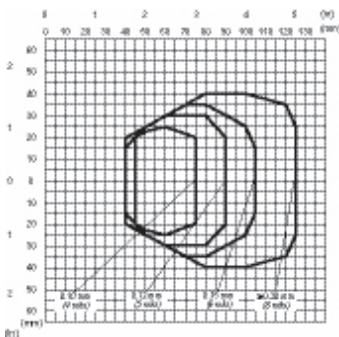

CONDITIONS

Code = Interleaved 2/5 or Code 39
 PCS = 0.90
 Pitch angle = 0°
 Skew angle = 15°
 Tilt angle = 0°

DIMENSIONS

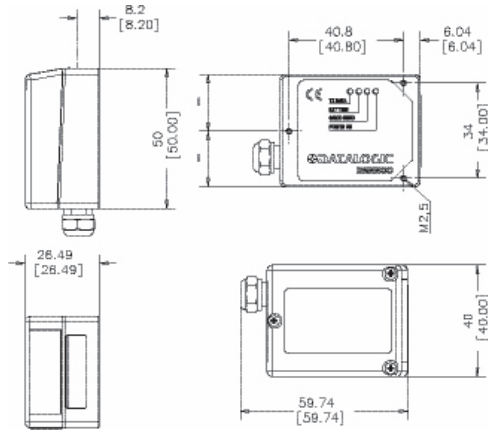

mm / inch

ELECTRICAL CONNECTIONS

All DS2200 models are equipped with a cable terminated with a 25-pin female D-sub connector for connection with the power supply and input/output signals.

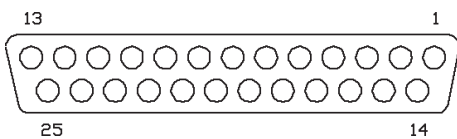

25-pin Female D-sub Connector

25-PIN D-SUB CONNECTOR PINOUT

Pin	Name	Function
9,13	VS	Power supply input voltage +
25	GND	Power supply input voltage -
1	CHASSIS	Chassis Ground
19	EXT TRIG-	External Trigger -
10,12,22	I/O REF	I/O reference
8	OUT1 +	Output 1 +
11	OUT2 +	Output 2 +
2	TXAUX	TX RS232 Aux. Interface
3	RXAUX	RX RS232 Aux. Interface
4	RTX485-	RTX- RS485 Main Interface
5	RTX485+	RTX+ RS485 Main Interface
7	SGND	Signal Ground
16	NGND	Internal Use - for Service only
17	FPE	Internal Use - for Service only
6,14,15,18,20,21,23,24	NC	Not Connected

MODELS AND ACCESSORIES

MODELS	
Order No.	Description
930161000	DS2200-1100 STD RESOLUTION, LINEAR, RS485+RS232, 5V
930161030	DS2200-1110 STD RESOLUTION, R1, RS485+RS232, 5V
930161040	DS2200-2100 HIGH RESOLUTION, LINEAR, RS485+RS232, 5V
930161050	DS2200-2110 HIGH RESOLUTION, R1, RS485+RS232, 5V

ACCESSORIES	
Order No.	Description
93A201030	GFC-2200 90° READING MIRROR
93ACC1040	DC5-2200 DC CONVERTER 4-30 VDC TO 5 VDC

TECHNICAL DATA

DIMENSIONS	50 x 40 x 28 mm (1.97 x 1.57 x 1.10 in)	
WEIGHT	150 g (5.29 oz.)	
CASE MATERIAL	Die-cast Zinc	
OPERATING TEMPERATURE	0 to 40 °C (32 to 104 °F)	
STORAGE TEMPERATURE	-20 to 70 °C (-4 to 158 °F)	
HUMIDITY	90% non condensing	
VIBRATION RESISTANCE	IEC 68-2-6 test FC 1.5mm; 10 to 55 Hz; 2 hours on each axis	
SHOCK RESISTANCE	IEC 68-2-27 test EA 30 G; 11 ms; 3 shocks on each axis	
PROTECTION CLASS	IP65	
LIGHT SOURCE	Visible laser diode (630 to 680 nm)	
SCANNING SPEED	500 scans/sec	
	DS2200-11x0	DS2200-21x0
RESOLUTION	Up to 0.15 mm (6 mils)	Up to 0.076 mm (3 mils)
READING DISTANCE	Up to 220 mm on 0.60 mm (24 mils) codes	Up to 125mm on 0.20 mm (8 mils) codes
DEPTH OF FIELD	Up to 170 mm on 0.60 mm (24 mils) codes	Up to 85 mm on 0.20 mm (8 mils) codes
APERTURE ANGLE	52 degrees	62 degrees
RASTER APERTURE	15 mm (0.6 in) at 220 mm (8.7 in) for R1 Raster models	
READABLE CODES	Code 2/5, Code39, Code93, Code128, EAN/UPC, EAN128, Codabar, Pharmacode	
MULTILABEL READING	Up to 6 different symbologies during the same reading phase	
COMMUNICATION INTERFACES	Main port RS485 Half Duplex up to 115.2 Kbit/s	
	Auxiliary port RS232 up to 115.2 kbps	
DIGITAL INPUTS	External Trigger (NPN only)	
DIGITAL OUTPUTS	Two SW programmable, event driven	
DEVICE PROGRAMMING	Windows™ based SW (WinHost™) via serial link	
	Serial Host Mode Programming sequences	
OPERATING MODES	'On-line', 'Serial On-line', 'Automatic', 'Test', 'Verifier'	
LED INDICATORS	Power On, External Trigger, Good Read, TX Data	
LASER CLASSIFICATION	IEC 825-1 Class2; CDRH Class II	
LASER CONTROL	Safety system to turn laser off in cases of motor slowdown or failure	
POWER SUPPLY	5 VDC (4 to 30 VDC with converter)	
POWER CONSUMPTION	2 W max	

Legacy Technology Services

We Rent & Sell All Types Of Barcode Equipment

Call now to talk to an expert

866-271-9891

www.LegacyGlobal.com

Some brands we carry



MOTOROLA

Intermec

DATALOGIC™

Honeywell

EQUINOX
PAYMENTS

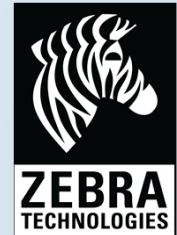

About us

- Legacy Technology Services is a leading nationwide provider of mobile computing, barcode, printers and point of sale equipment and services.
- For over a decade, thousands of clients across North America have trusted us to provide equipment from leading manufacturers backed by the services to support them.

Latest Hardware from top manufacturers

- Legacy handles virtually every major manufacturer of mobile computing, barcoding and point of sale equipment.

Expert Repair and Maintenance services

- Legacy is one of the best repair facilities in North America

Discontinued product sourcing

- They don't make it anymore? Our inventory also includes manufacturer close-outs and discontinued equipment to support our clients legacy infrastructure.

Trade-in and Disposal services

- That old equipment laying around your facility may still have some value. Legacy routinely purchases equipment from our clients around the globe.
 - Data destruction
 - Hardware disposal
 - Auditing services

Dedicated client account team

- Dedicated, highly trained account managers are here to answer all your questions and provide top notch service.

Equipment rental services

- Sometimes renting is a better solution, Legacy's huge rental inventory provides the equipment you need for temporary needs and projects.



Legacy, Inc.

160 West Road,
Ellington, CT 06029

Toll Free: 866-271-9891

Fax: 888-522-4684